



Emax EVolution

ULTRA-PRECISION BRUSHLESS MICRO-GRINDER



CAUTION

Electric System

Air System

Ultrasonic

General Parts

Exclusive Tools

CAUTION

Electric System

Air System

Ultrasonic

General Parts

Exclusive Tools

ADVANCED HIGH PERFORMANCE BRUSHLESS MICRO-GRINDER

Emax **EVolution Series**

Emax **EVolution SERIES** ◀◀

“Powerful Torque”

“Easy to Recognize Live Load Indicator”

“No need to replace carbon brushes”
(Brushless motor)



1,000~40,000 min⁻¹

Emax **EVolution Standard Set**

Code No.	8233 (120V)	Model	EV410-120
Code No.	8225 (230V)	Model	EV410-230

※ Please check the power source plug type (p.4-6).

Standard Equipment

- Micro Grinder (IR-310+ENK-410S) : 1 pc.
- Collet ø3.0 mm (CHH-3.0), ø2.35 mm (CHH-2.35) : 1 pc. each
- Controller (NE249) : 1 pc.
- Accessories : Handpiece Holder : 1 pc., Handpiece Stand : 1 pc.
Power Supply Cord : 1 pc., Wrench (7 x 5.1) : 1 pc.
Pin Wrench (K-233) : 2 pcs., L Shaped Wrench (9) : 1 pc.

※ Torque set → p.1-20



Example of Applications



Tool : Electroplated Diamond Burs



Tool : Diamond Grinding Discs



Tool : Flap Wheels



Tool : Abrasive Belts → p.5-32



Tool : Sand Paper Disk → p.5-25~26



Tool : Felt Bobs

CAUTION

Electric System

Air System

Ultrasonic

General Parts

Exclusive Tools

CAUTION

Electric System

Air System

Ultrasonic

General Parts

Exclusive Tools

ADVANCED HIGH PERFORMANCE CONTROLLER

Emax EVolution Controller

Advanced Control Function

Upgraded Digital Display. EVOLUTION on Speed Control Volume with easy to recognize Load Indicator.



Motor speed digital display

Load Meter

- Continuous load area
- Intermittent load area
- Overload

Forward / Reverse Select Switch
Forward / Reverse rotation can be selected.

ø12mm Speed Control Volume
Easy to operate by one finger

Motor A
ON / OFF Function

Emax EVolution Controller

Code No.	8224 (120V)	Model	NE249 120
Code No.	8227 (230V)	Model	NE249 230

Specifications

Description	Emax EVolution Controller
Power Source	AC120/230V, 50-60Hz
Dimensions	W130 x D254 x H97 mm
Weight	2.3 kg

Accessories : Handpiece Holder : 1 pc., Handpiece Stand : 1 pc.
Power Supply Cord : 1 pc.

Memory Speed Function FiXspeed®

A new feature is the "FiXspeed®" function, which allows the user to memorize RPMs in advance. The frequently used speed can be set at the touch of a button regardless of the volume position. Furthermore, A and B can be set independently, so A can be controlled by FiXspeed and B can be controlled variably with a foot controller to help improve work efficiency.

Auto Cruise Function

An Auto Cruise function is provided to fix the rpm at a fixed speed while working with the foot controller. This function allows the operator to work without using the foot controller when continuously performing the same task, thus reducing foot fatigue.



Memory Speed Function FiXspeed®

Motor B
ON / OFF Function

⚠ Never connect to E-max Series motor.
※ Please check the power source plug type (p.4-6).

Diversity for work efficiency

2 Sets of motors can be connected at the same time, to further improve work efficiency. (The motors cannot be used simultaneously)



Advanced User Friendly Design

Integrated handle for carrying. The design ensures ease of use by allowing the handpiece and tools to be placed on the top.



ADVANCED HIGH PERFORMANCE BRUSHLESS MOTOR

Emax EVolution Motor

Excellent Durability



- High performance brushless motor eliminates the need of changing carbon brushes.
- RPM variation is minimal even when load changes. Allowing difficult and stable cutting in stress free motion. Suitable performance for finish grinding.
- Provides superior quietness and smoothness from low speed to high speed.

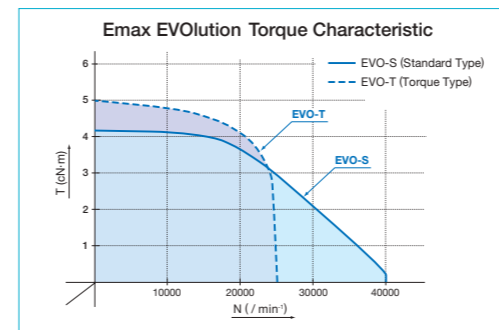

2 Types of Motors

Provides choice of various applications.

- Standard Type Motor 1,000~40,000 min⁻¹ (ENK-410S) Blue
- Torque Type Motor 1,000~25,000 min⁻¹ (ENK-250T) Green

※ Exclusive use for Emax EVolution

NAKANISHI Smart Switch

The switch provides a click sensation. A confirmation tone is reacted by the controller when the switch is operated. The motor type is distinguishable by the switch color.



Standard Type Motor

Code No.	8086
Model	ENK-410S

1,000~40,000 min⁻¹

• Excellent combination of high speed, lightweight, small diameter and high torque. This lightweight and compact general-use type is perfect for precision work.

- ◆ Max. Power : 73 W
- ◆ Max. Torque : 4.3 cN·m
- ◆ With Straight Cord : 1.5 m
- ◆ Weight : 90 g (w/o cord)

Standard Accessories
• Pin Wrench (K-233) : 1 pc.

⚠ Never connect to E-max Series controller.



Switch Color : Blue

Torque Type Motor

Code No.	8087
Model	ENK-250T

1,000~25,000 min⁻¹

• Combines the best of both high speed and high torque. It is perfect for applications requiring large burs.

- ◆ Max. Power : 76 W
- ◆ Max. Torque : 4.8 cN·m
- ◆ With Straight Cord : 1.5 m
- ◆ Weight : 147 g (w/o cord)

⚠ Never connect to E-max Series controller.



Switch Color : Green

Code No.	Model
----------	-------

Attachment

※Compatible with attachments from E-max and ROTUS system.

1147	IR-310
------	--------



Ring Type

1005	IH-300
------	--------



Lever Type

1016	HG-200
------	--------



6 mm Torque Type¹

1017	BMH-300
------	---------



Long Type

1012	MFC-300S
------	----------



90° Mini Angle Type

1013	MFC-300M
------	----------



90° Mini Angle Type (Very Small Head)

1006	IC-300
------	--------



90° Angle Type

1014	KC-300
------	--------



50° Angle Type

LUSTER	1302	LS-100
--------	------	--------



Pistol-Type Polisher (Reciprocating motion)

MINI-LUSTER	1307	ML-8
-------------	------	------



Pencil-Type Reciprocating Polishing Finisher (Reciprocating motion)

SWING-LUSTER	1380	SLS-16
--------------	------	--------



Pencil-Type Reciprocating Polishing Finisher (Right to Left motion)

Hammer Action Type	8060	HA-500
--------------------	------	--------



Engraving and Ornament Processing Work Hammer

FINE BELT SANDER	1146	KBS-101
------------------	------	---------



Small-sized Handy Belt Sander



Pistol-Type Polisher (Reciprocating motion) Built-in Motor

LUSTER	1483	NLS-110
--------	------	---------

Exclusive use for Emax EVOLUTION

- Wide selection of attachments available depending on the application.

Speed Reducer·Extension Joint



Extension Joint	1015	CN-01
-----------------	------	-------



1/4 Speed Reducer	1009	RG-01
-------------------	------	-------



1/15 Speed Reducer	1010	RG-02
--------------------	------	-------

※ Can be connected between the motor and the attachment when a higher level of torque is required.

Motor

Emax EVolution Series



• Standard Type Motor with Cord	8086	ENK-410S	1,000-40,000 min ⁻¹
---------------------------------	------	----------	--------------------------------



• Torque Type Motor with Cord	8087	ENK-250T	1,000-25,000 min ⁻¹
-------------------------------	------	----------	--------------------------------

Exclusive use for Emax EVOLUTION

ROTUS Series

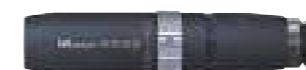

• Air Motor with Hose 360° Twist-Free Joint Mechanism	1004	IM-301	3,000-30,000 min ⁻¹
---	------	--------	--------------------------------

Controller

Emax EVolution



8224 (120V)	NE249 120
8227 (230V)	NE249 230

• Foot Controller



8106	FC-64
------	-------

Electric System

Sets



Emax EVolution Standard Set

Code No.	Model
8233 (120V)	EV410-120
8225 (230V)	EV410-230

Standard Equipment

- Micro Grinder (IR-310+ENK-410S) : 1 pc.
- Collet ø3.0 mm (CHH-3.0), ø2.35 mm (CHH-2.35) : 1 pc. each
- Controller (NE249) : 1 pc.
- Accessories : Handpiece Holder : 1 pc. Handpiece Stand : 1 pc. Power Supply Cord : 1 pc. Wrench (7 x 5.1) : 1 pc. Pin Wrench (K-233) : 2 pcs. L Shaped Wrench (9) : 1 pc.

Air System

• Air Line Kit



4507	AL-H1207F
------	-----------

• Foot Controller



1064	AFC-45
------	--------

※This Air Line Kit is designed for use with the AFC-45 Foot Controller, Code No.1064.



ROTUS Standard Set

Code No.	Model
1163	ROTUS-IR

Standard Equipment

- Air Grinder (IR-310+IM-301) : 1 pc.
- Collet ø3.0mm (CHH-3.0), ø2.35 mm (CHH-2.35) : 1 pc. each
- Air Line Kit (AL-H1207F) : 1 pc.
- Foot Controller (AFC-45) : 1 pc.
- Accessories : Piping Hose 2m (K-275) : 1 pc. Lubricating Oil (K-211) : 1 pc. Wrench (7 x 5.1) : 1 pc. Pin Wrench (K-233) : 2 pcs. L Shaped Wrench (9) : 1 pc.

⚠ Details of Maximum Allowable speed on intermittent use or continuous use p.1-11-20

<Caution>

※1 : Use 6 mm Torque Type ENK-250T to connect HG-200

RING TYPE MICRO-GRINDER ◀◀

PRECISION MICRO-GRINDER

Ring Type Attachment

Ring Type Chucking System

- One-touch ring type bur replacement.
- High precision and high reliability is realized by micron grade precision.
- Slim, lightweight design allows fine finishing on delicate parts.



40,000 min⁻¹ Max.

◆ Weight : 92 g

Standard Size Collet

ø3.0 mm (CHH-3.0) ø2.35 mm (CHH-2.35)

Optional Collets : CHH Group are shown in page (p.4-3)

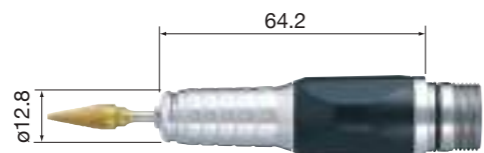

Code No. **1147** Model **IR-310**

Standard Accessories

- Wrench (7 x 5.1) : 1 pc. • Pin Wrench (K-233) : 1 pc.
- L Shaped Wrench (9) : 1 pc.

LONG TYPE MICRO-GRINDER ◀◀

PRECISION MICRO-GRINDER

Long Type Attachment

Tip diameter ø13 mm

- This unique slim body makes it ideal for cutting and grinding the bottom surface of deep ribs or holes.
- Collet is tightened by a wrench.
- The tip diameter is ø13 mm.



35,000 min⁻¹ Max.

◆ Weight : 156 g

Standard Size Collet

ø3.0 mm (CHM-3.0)

Optional Collets : CHM Group are shown in page (p.4-4)

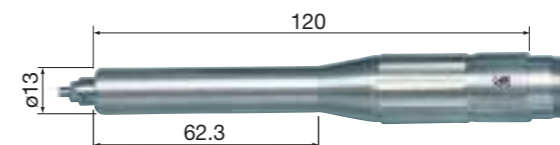

Code No. **1017** Model **BMH-300**

Standard Accessories

- Wrench (7 x 5.1), (6 x 4.5) : 1 pc. each
- Pin Wrench (K-233) : 1 pc.

Ring Type Attachment + Standard Type Motor Combination Example

1,000~40,000 min⁻¹

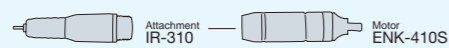

Long Type Attachment + Standard Type Motor Combination Example

1,000~35,000 min⁻¹



Ring Type Attachment + Torque Type Motor Combination Example

1,000~25,000 min⁻¹

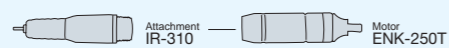

Emax EVolution Controller (p.1-7)
 <Code No. : 8224 (120V) · Model : NE249 120>
 <Code No. : 8227 (230V) · Model : NE249 230>

⚠ Never connect to E-max Series Controller.

Combination Example	d	D	l 1	l 2	L	Weight	Max. Torque	Speed Range	Collet
1147+8086	ø12.8	ø24.5	64.2	97	161.2	182 g (※)	4.3 cN·m	1,000~40,000 min ⁻¹	ø0.3~ø3.175 mm CHH Group (p.4-3)
1147+8087	ø12.8	ø28.4	64.2	108	172.2	239 g (※)	4.8 cN·m	1,000~25,000 min ⁻¹	ø0.3~ø3.175 mm CHH Group (p.4-3)

※ Weight (w/o Straight Cord)

Emax EVolution Controller (p.1-7)
 <Code No. : 8224 (120V) · Model : NE249 120>
 <Code No. : 8227 (230V) · Model : NE249 230>

⚠ Never connect to E-max Series Controller.

Combination Example	Outside Diameter	Weight	Max. Torque	Speed Range	Collet
1017+8086	Refer to the dimensions	246 g (※)	4.3 cN·m	1,000~35,000 min ⁻¹	ø0.3~ø3.175 mm CHM Group (p.4-4)

※ Weight (w/o Straight Cord)

CAUTION

Electric System

Air System

Ultrasonic

General Parts

Exclusive Tools

CAUTION

Electric System

Air System

Ultrasonic

General Parts

Exclusive Tools

MINI ANGLE TYPE MICRO-GRINDER ◀◀

ANGLE TYPE GRINDER

Mini Angle Type Attachment



For Chamfering Deep Hole | Bur Only $\phi 1.6$ mm | Exclusive Tools p.5-31

- Suitable for chamfering and deburring the inside of the slit pipe.
- The smallest angle type attachment in NAKANISHI's lineup.
- Various $\phi 1.6$ mm exclusive tools are available.

- 15,000 min⁻¹ Max.
- ◆ Minimum Inner Diameter : $\phi 13$ mm
 - ◆ Holding tool width : 7.2 mm ◆ Weight : 47 g
 - ◆ Speed Reduction Ratio : 10/11
- Standard Size Collet **$\phi 1.6$ mm (K-253)** p.4-4 **Exclusive Tools** p.5-31
- ◆ Minimum Inner Diameter : $\phi 20$ mm
 - ◆ Holding tool width : 11.9 mm ◆ Weight : 50 g
 - ◆ Speed Reduction Ratio : 10/11
- Standard Size Collet **$\phi 1.6$ mm (K-252)** p.4-4 **Exclusive Tools** p.5-31

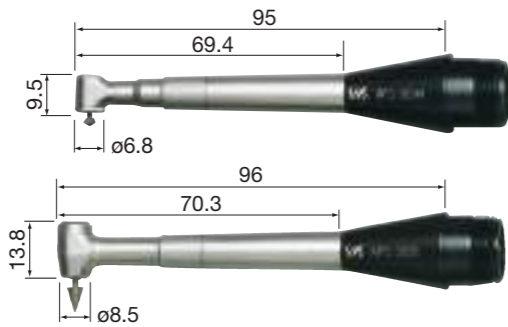

Mini Angle Type (Very Small Head)
Code No. **1013** Model **MFC-300M**

Standard Accessories
• Collet Wrench (K-232) : 1 pc. • Pin Wrench (K-233) : 1 pc.

Mini Angle Type
Code No. **1012** Model **MFC-300S**

Standard Accessories
• Collet Wrench (K-232) : 1 pc. • Pin Wrench (K-233) : 1 pc.

Mini Angle Type Attachment + Standard Type Motor Combination Example

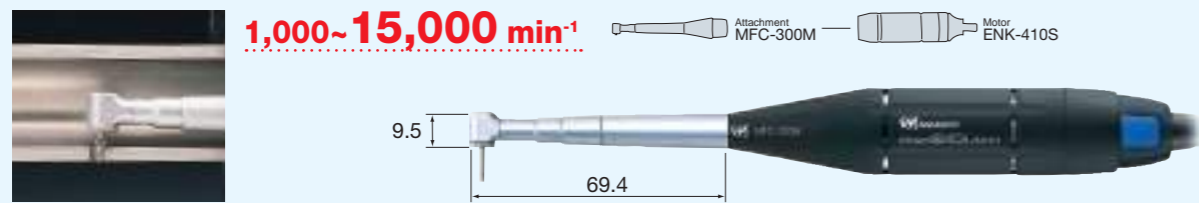

Mini Angle Type Attachment + Standard Type Motor Combination Example

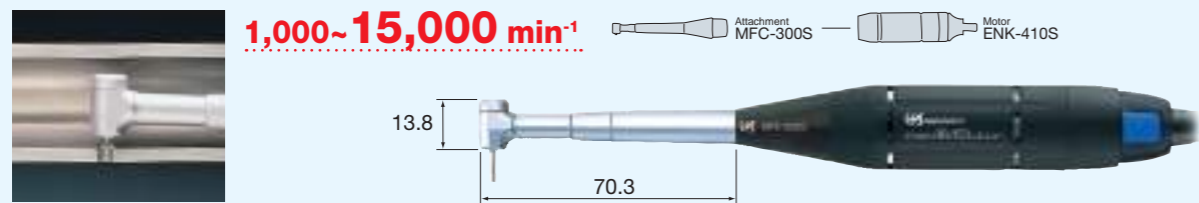

Emax EVolution Controller (p.1-7)
<Code No. : 8224 (120V) · Model : NE249 120>
<Code No. : 8227 (230V) · Model : NE249 230>

⚠ Never connect to E-max Series Controller.

Combination Example	d	D	l 1	l 2	L	Weight	Max. Torque	Speed Range	Collet
1013+8086	$\phi 6.8$	$\phi 24.5$	95	97	192	137 g (※)	4.3 cN·m	1,000~15,000 min ⁻¹	$\phi 1.6$ mm (K-253) (p.4-4)
1012+8086	$\phi 8.5$	$\phi 24.5$	96	97	193	140 g (※)	4.3 cN·m	1,000~15,000 min ⁻¹	$\phi 1.6$ mm (K-252) (p.4-4)

※ Weight (w/o Straight Cord)



ANGLE TYPE MICRO-GRINDER ◀◀

ANGLE TYPE GRINDER

Angle Type Attachment



Most suitable for polishing flat surfaces at speed | Exclusive Tools p.5-25~30

- Suitable for grinding and polishing process with shaft mounted tools.
- Perfect for finishing bottom surfaces and other tight, hard to reach areas.

- 30,000 min⁻¹ Max.
- ◆ Weight : 45 g
 - ◆ Speed Reduction Ratio : 3/4
- Standard Size Collet **$\phi 3.0$ mm (CHC-3.0)** **Exclusive Tools** p.5-25~30
- Optional Collets : CHC Group are shown in page (p.4-3)
- ◆ Weight : 45 g
 - ◆ Speed Reduction Ratio : 3/4
 - ◆ Use the motor in reverse rotation for clockwise rotation.
- Standard Size Collet **$\phi 3.0$ mm (CHC-3.0)** **Exclusive Tools** p.5-25~30
- Optional Collets : CHC Group are shown in page (p.4-3)

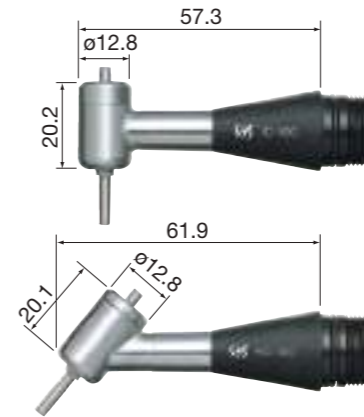

Angle Type (90°)
Code No. **1006** Model **IC-300**

Standard Accessories
• Collet Wrench (K-231) : 1 pc. • Pin Wrench (K-233) : 1 pc.
• Standard Accessories : 1 set

Angle Type (50°)
Code No. **1014** Model **KC-300**

Standard Accessories
• Collet Wrench (K-231) : 1 pc. • Pin Wrench (K-233) : 1 pc.
• Standard Accessories : 1 set

90° Angle Type Attachment + Standard Type Motor Combination Example

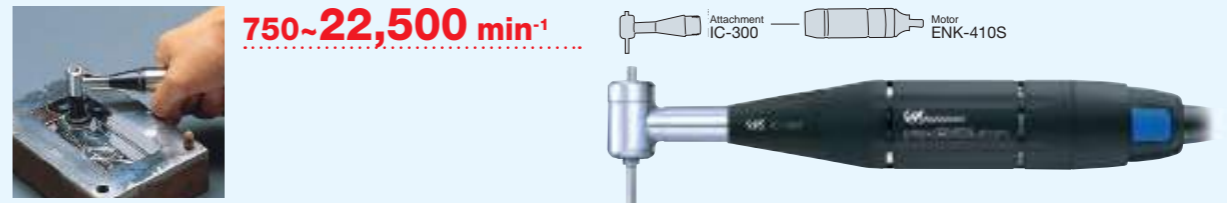

50° Angle Type Attachment + Standard Type Motor Combination Example

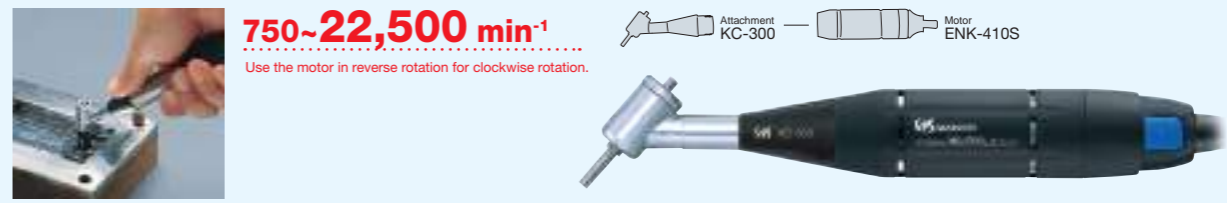

Emax EVolution Controller (p.1-7)
<Code No. : 8224 (120V) · Model : NE249 120>
<Code No. : 8227 (230V) · Model : NE249 230>

⚠ Never connect to E-max Series Controller.

Combination Example	d	D	l 1	l 2	L	Weight	Max. Torque	Speed Range	Collet
1006+8086	20.2	$\phi 24.5$	57.3	97	154.3	135 g (※)	4.3 cN·m	750~22,500 min ⁻¹	$\phi 1.0$ ~ $\phi 3.175$ mm
1014+8086	20.1	$\phi 24.5$	61.9	97	158.9	135 g (※)	4.3 cN·m	750~22,500 min ⁻¹	CHC Group (p.4-3)

※ Weight (w/o Straight Cord)

Code No.	Description	Package
64101	Rubber Pad (Small) O.D. $\phi 10$ mm	1 pc./pack
64102	Rubber Pad (Med) O.D. $\phi 20$ mm	
64103	Rubber Pad (Large) O.D. $\phi 30$ mm	
64203	Sand Paper Disk for small pad $\phi 11$ #180	5 pcs./pack
64207	Sand Paper Disk for small pad $\phi 11$ #600	

Code No.	Description	Package
64213	Sand Paper Disk for med. pad $\phi 21$ #180	5 pcs./pack
64217	Sand Paper Disk for med. pad $\phi 21$ #600	
64223	Sand Paper Disk for large pad $\phi 31$ #180	
64227	Sand Paper Disk for large pad $\phi 31$ #600	

• Exclusive tools for Angle Type Attachment p.5-25~30

MINI-LUSTER ◀◀

PENCIL-TYPE RECIPROCATING POLISHING FINISHER

MINI-LUSTER Attachment



Stroke Range 0.8 mm Reciprocating Motion Exclusive Tools p.5-19~22

- The pencil type grip is most suitable for polishing narrow grooves, details, etc.
- Lightweight, compact design and minimal vibration helps keep the hand free from fatigue for long continuous operation.
- By using the provided grindstone holder, various tools such as oil stones, super stones, diamond files, etc. can be used.

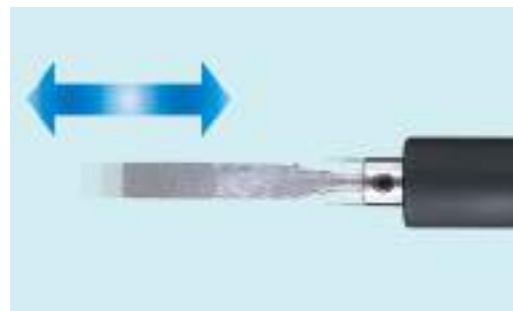

25,000 min⁻¹ Max.
 ◆ Stroke Range (Fixed) : 0.8 mm
 ◆ Reciprocating Stroke (Variable) : 0~6,380 times/min
 ◆ Weight : 130 g
 ◆ Max. tool shank diameter ø3.5 mm, Screw clamp type

Exclusive Tools p.5-19~22



Code No. **1307** Model **ML-8** Stroke (0.8 mm)

Standard Accessories
 • Allen Wrench (1.5 mm) : 1 pc.
 • Standard Accessories : 1 set

SWING-LUSTER ◀◀

PENCIL-TYPE RECIPROCATING POLISHING FINISHER

SWING-LUSTER Attachment



Stroke Range 0~1.6 mm Right to Left Motion Exclusive Tools p.5-23~24

- High speed grinding and polishing operations can be performed while maintaining the fine and delicate feel of hand polishing.
- Lightweight pencil type design makes it easy to work in tight areas.
- Ergonomically designed to provide high sensitivity for precision work.
- Easily adjustable stroke length allows efficient work on minute areas of large sections.

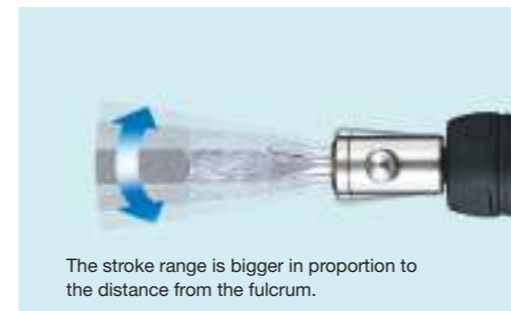

30,000 min⁻¹ Max.
 ◆ Reciprocating Stroke (variable) : 0~7,650 times/min
 ◆ Stroke Range (variable) : 0~1.6 mm
 ◆ Weight : 127 g
 ◆ Max. tool shank diameter ø5.0 mm, Screw clamp type

Exclusive Tools p.5-23~24



Code No. **1380** Model **SLS-16**

Standard Accessories
 • Wrench (16 x 18), (20 x 24) : 1 pc. each
 • Allen Wrench (1.5 mm) : 1 pc.
 • Standard Accessories : 1 set

MINI-LUSTER Attachment + Standard Type Motor Combination Example

Reciprocating Stroke
0~6,380 times/min

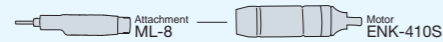

SWING-LUSTER Attachment + Standard Type Motor Combination Example

Reciprocating Stroke
0~7,650 times/min

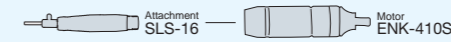

Emax EVolution Controller (p.1-7)
 <Code No. : 8224 (120V) · Model : NE249 120>
 <Code No. : 8227 (230V) · Model : NE249 230>

⚠ Never connect to E-max Series Controller.

189, 182.4, 85.4, 97, ø15, ø24.5

Combination Example	Outside Diameter	Weight	Max. Torque	Reciprocating Stroke	Max. Tool Shank
1307+8086	Refer to the dimensions	220 g (※)	4.3 cN·m	0~6,380 times/min	ø3.5 mm (screw clamp type)

Standard Accessories

Code No.	Description	Package
62751	Spring Holder	1 pc. each
62510	Ceramic Fiber Grindstone Holder	
62814	Electroplated Diamond File 1.25 x 4 x 50 #100	
60520	Ceramic Fiber Grindstone 1 x 6 x 50 #1200	

• Exclusive tools p.5-19~22

※ Weight (w/o Straight Cord)

Emax EVolution Controller (p.1-7)
 <Code No. : 8224 (120V) · Model : NE249 120>
 <Code No. : 8227 (230V) · Model : NE249 230>

⚠ Never connect to E-max Series Controller.

203.1, 184, 87, 97, ø17.5, ø24.5

Combination Example	Outside Diameter	Weight	Max. Torque	Reciprocating Stroke	Max. Tool Shank
1380+8086	Refer to the dimensions	217 g (※)	4.3 cN·m	0~7,650 times/min	ø5.0 mm (screw clamp type)

Standard Accessories

Code No.	Description	Package
62510	Ceramic Fiber Grindstone Holder	1 pc. each
62814	Electroplated Diamond File 1.25 x 4 x 50 #100	
60520	Ceramic Fiber Grindstone 1 x 6 x 50 #1200	

• Exclusive tools p.5-23~24

※ Weight (w/o Straight Cord)

FINE BELT SANDER ◀◀

SMALL-SIZED HANDY BELT SANDER

FINE BELT SANDER Attachment



Exclusive Tools p.5-32

- Very high belt speed, ideal for applications from deburring to finishing.
- Belt runs Approx. 0~705 m/min
- Lightweight, compact, minimal vibration and a small diameter grip design helps keep the hand free from fatigue for long, continuous operation.
- The angle of the belt section is fully adjustable.
- The belt can be changed easily with the lever release.
- 4, 6, 8 mm width belts are available.



30,000 min⁻¹ Max.
 ◆ Belt Speed : 0~705 m/min
 ◆ Weight : 350 g ◆ Belt Sizes : 4, 6, 8 mm Wide × 300 mm long

Exclusive Tools p.5-32



Code No. **1146** Model **KBS-101**

Standard Accessories
 • Allen Wrench (3 mm) : 1 pc. • Standard Accessories : 1 set

FINE BELT SANDER Attachment + Standard Type Motor Combination Example

o~705 m/min

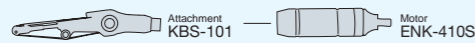

Emax EVolution Controller (p.1-7)
 <Code No. : 8224 (120V) · Model : NE249 120>
 <Code No. : 8227 (230V) · Model : NE249 230>

⚠ Never connect to E-max Series Controller.

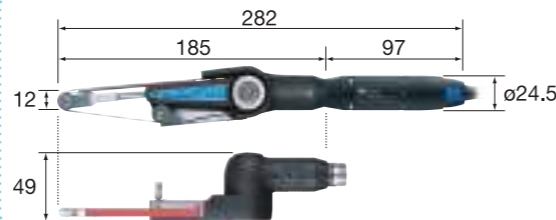

Combination Example	Outside Diameter	Weight	Max. Torque	Belt Speed	Belt Width
1146+8086	Refer to the dimensions	440 g (※)	4.3 cN·m	0~705 m/min	4 mm, 6 mm, 8 mm

※ Weight (w/o Straight Cord)

Code No.	Description	Package
64902	Abrasive Belt Width 4 mm #120	2 pcs. each
64904	Abrasive Belt Width 4 mm #240	
64906	Abrasive Belt Width 4 mm #400	
64912	Abrasive Belt Width 6 mm #120	
64914	Abrasive Belt Width 6 mm #240	
64916	Abrasive Belt Width 6 mm #400	
64922	Abrasive Belt Width 8 mm #120	
64924	Abrasive Belt Width 8 mm #240	
64926	Abrasive Belt Width 8 mm #400	

Spare Parts

Product	Description	Code No.	Model
	Tension Pulley	1103	TP-12A
	Tension Pulley Assembly	1104	TPA-12A

LUSTER ◀◀

PISTOL-TYPE RECIPROCATING POLISHING FINISHER

LUSTER Emax EVolution

With Motor ON / OFF Switch Reciprocating Motion Exclusive Tools p.5-13~18

- Powerful reciprocating stroke polisher equipped with 1/4 Speed Reducer to multiply the torque by 4 times.
- Reciprocating speed and stroke can be easily and continuously controlled.
- LUSTER NLS has a built-in motor. Insert the cord plug into the controller.



LUSTER Emax EVolution

Reciprocating Stroke
0~6,300 times/min

Code No. **1483**
 Model **NLS-110**



25,000 min⁻¹ Max.
 Specifications
 Stroke Range : 0~6 mm (variable)
 Reciprocating Stroke : 0~6,300 times/min (variable)
 Max. Torque : 17.2 cN·m
 Weight : 800 g (w/o cord)
 With Straight Cord : 1.5 m
 Standard Accessories
 • Allen Wrench (2 mm), (3 mm) : 1 pc. each
 • Lubricating Oil
 • Lubrication Nozzle for LUSTER
 • Standard Accessories : 1 set

Emax EVolution Controller (p.1-7)
 <Code No. : 8224 (120V) · Model : NE249 120>
 <Code No. : 8227 (230V) · Model : NE249 230>
 ⚠ Never connect to E-max Series Controller.

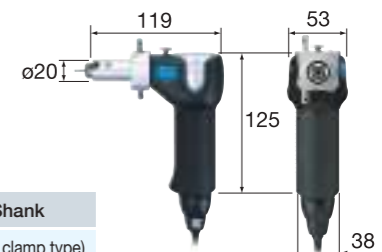

Code No.	Outside Diameter	Weight	Max. Torque	Reciprocating Stroke	Max. Tool Shank
1483	Refer to the dimensions	800 g (※)	17.2 cN·m	0~6,300 times/min	ø6.4 mm (screw clamp type)

※ Weight (w/o Straight Cord)

Code No.	Description	Package
62502	Stone Holder	1 pc./pack
62505	Stone Holder	
62751	Spring Holder	
62525	Rectangular Pad	
62526	Rod for Rectangular Pad	
62527	Angle Rod	1 pc./pack
62552	Sand Paper Tip #120	10 pcs./pack
62555	Sand Paper Tip #320	
62557	Sand Paper Tip #600	
62559	Sand Paper Tip #1000	

• Exclusive tools for LUSTER p.5-13~18

Lever Type Attachment

Code No. **1005** Model **IH-300**



40,000 min⁻¹ Max.

- High precision and high reliability is realized by micron grade precision.
- Slim, lightweight design allows fine finishing of delicate parts.
- Lever Type one touch bur release.



◆ Weight : 62 g
 Standard Size Collet
ø3.0 mm (CHH-3.0) ø2.35 mm (CHH-2.35)
 Optional Collets : CHH Group are shown in page (p.4-3)
 Standard Accessories
 • Wrench (7 x 5.1) : 1 pc. • Pin Wrench (K-233) : 1 pc.
 • L Shaped Wrench (9) : 1 pc.

6 mm Torque Type Attachment

Code No. **1016** Model **HG-200**

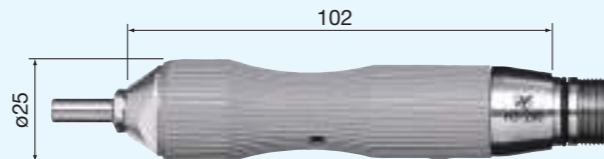

Use ENK-250T to connect HG-200.

30,000 min⁻¹ Max.

- ø6.0 mm shank burs ready.
- The resistance produced by cutting and grinding is absorbed by a special rubber grip to eliminate slipping.
- Collet is tightened by a wrench.



◆ Weight : 210 g
 Standard Size Collet
ø6.0 mm (CHG-6.0)
 Optional Collets : CHG Group are shown in page (p.4-3)
 Standard Accessories
 • Wrench (10 x 10) : 1 pc. • Bar Wrench (K-212) : 1 pc.
 • Pin Wrench (K-233) : 1 pc.

1/4 Speed Reducer

Code No. **1009** Model **RG-01**

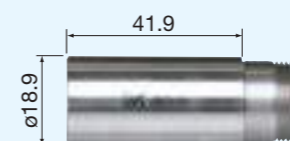

30,000 min⁻¹ Max.

- Mounted between an attachment and a motor.
- The speed is reduced to 1/4 while the torque is multiplied by 4 times.
- Suitable for high torque grinding process or drilling.

◆ Weight : 68 g

Standard Accessories
 • Pin Wrench (K-233) : 1 pc.

Extension Joint

Code No. **1015** Model **CN-01**

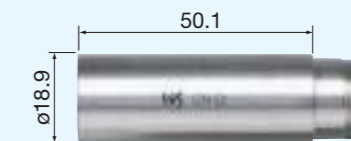

35,000 min⁻¹ Max.

- Speed Ratio 1 : 1
- This is a joint to be connected between a motor and an attachment to extend the total length of the attachment.

◆ Weight : 83 g

Standard Accessories
 • Pin Wrench (K-233) : 1 pc.

LUSTER Attachment (Pistol-Type Polisher)

Code No. **1302** Model **LS-100**

Reciprocating motion



25,000 min⁻¹ Max.

- High performance grinding & polishing with high power and reciprocating stroke.
- Well-balanced, rubber-grip absorbs vibration.
- Stroke Range : 0~6 mm (variable)
- Reciprocating Stroke : 0~6,300 times/min (variable)



◆ Weight : 680 g
 ◆ Max. tool shank diameter ø6.4 mm, Screw clamp type
 Standard Accessories
 • Allen Wrench (2 mm), (3 mm) : 1 pc. each
 • Lubricating Oil • Lubrication Nozzle for LUSTER
 • Standard Accessories : 1 set

Exclusive Tools p.5-13~18

Code No.	Description	Package
62502	Stone Holder	1 pc./pack
62505	Stone Holder	
62751	Spring Holder	
62525	Rectangular Pad	
62526	Rod for Rectangular Pad	10 pcs./pack
62527	Angle Rod	
62552	Sand Paper Tip #120	
62555	Sand Paper Tip #320	
62557	Sand Paper Tip #600	
62559	Sand Paper Tip #1000	

Hammer Attachment

Code No. **8060** Model **HA-500**

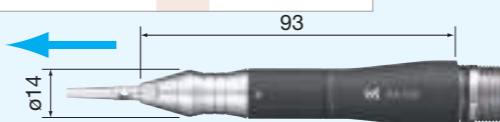

16,000 min⁻¹ Max.

- A wide variety of patterns can be produced by adjusting the spring pressure and hammer speed.
- Lightweight, pencil type grip makes the handpiece very comfortable to hold and easy to use.
- Adjustable spring pressure. ◆ Weight : 95 g
- Self lubricating hammer mechanism ensure excellent durability.
- Stroke Range : 0.4 mm ◆ Stroke Times : 25~4,000 times/min
- ◆ Stroke Spring Pressure : 4.4~7.1 N (Ring Adjustment Type)

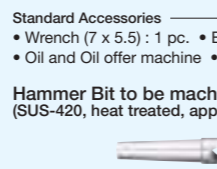

Standard Accessories
 • Wrench (7 x 5.5) : 1 pc. • Bar Wrench (K-212) : 1 pc.
 • Oil and Oil offer machine • Hammer Bit (For replacement) : 2 pcs.
 Hammer Bit to be machined to required shapes (SUS-420, heat treated, approx, HRC50)

Code No.	Package
65301	3 pcs./pack

1/15 Speed Reducer

Code No. **1010** Model **RG-02**

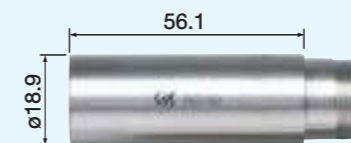

30,000 min⁻¹ Max.

- Mounted between an attachment and a motor.
- The speed is reduced to 1/15 while the torque is multiplied by 15 times.
- Suitable for high torque grinding process or drilling.

◆ Weight : 93 g

Standard Accessories
 • Pin Wrench (K-233) : 1 pc.

Foot Controller

Code No. **8106** Model **FC-64**

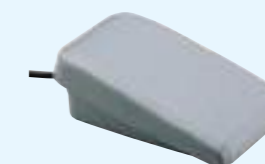

- Variable speed control.
- For Emax EVolution (NE249)

Emax EVolution Torque Set

1,000~25,000 min⁻¹



For heavy duty and larger tools, the Torque type promises to expand the range of operation.

Ring Type IR-310 is the standard attachment for Emax EVolution torque set EV250-120, EV250-230.

Code No. **8234** (120V) Model **EV250-120**

Code No. **8226** (230V) Model **EV250-230**

※ Please check the power source plug type (p.4-6).

- Standard Equipment
- Micro Grinder (IR-310+ENK-250T) : 1 pc.
 - Collet ø3.0 mm (CHH-3.0), ø2.35 mm (CHH-2.35) : 1 pc. each
 - Controller (NE249) : 1 pc.
 - Accessories : Handpiece Holder : 1 pc., Handpiece Stand : 1 pc.
 Power Supply Cord : 1 pc., Wrench (7 x 5.1) : 1 pc.
 Pin Wrench (K-233) : 1 pc., L Shaped Wrench (9) : 1 pc.





For safe usage





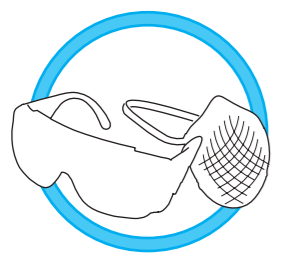
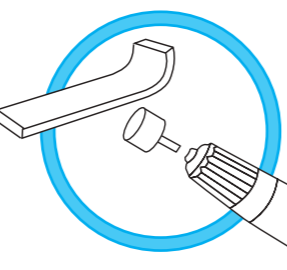
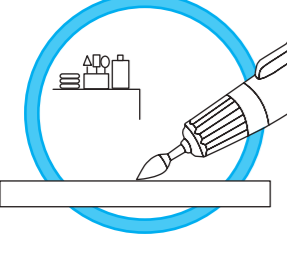

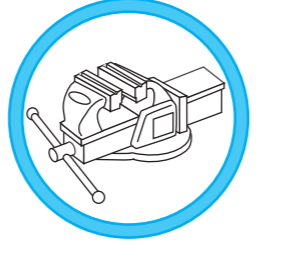
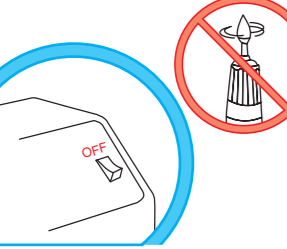

- Please read operation manuals before using any NAKANISHI product.
- Please keep the operation manuals on hand so that the user can refer to them at any time.

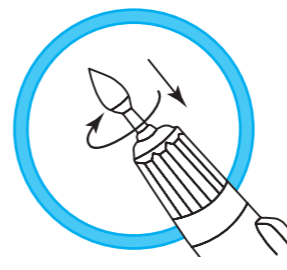
⚠ Caution

Incorrect use of the product, or ignoring 'CAUTIONS for safety' described in the operating manuals may cause fatal or serious bodily injury.

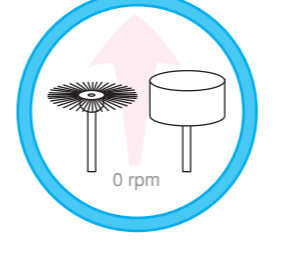
CAUTIONS

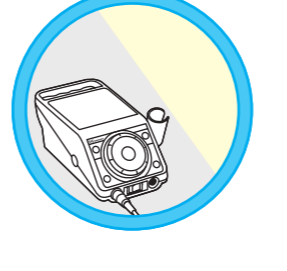
 <p>Always use safety glasses, masks, face guards for your safety.</p>	 <p>Select proper hand tools and for your application. Select tools carefully considering the performance of the hand tools, work procedure and type / shape of the material.</p>
 <p>Do not touch the tools and hand tools when in operation. Make sure the work area is neat and there is sufficient light.</p>	 <p>Do not wear loose clothing and/or accessories that may be caught in machinery. Long hair should be tied prior to machine operation.</p>
 <p>Do not operate the products where flammable liquids or gases exist.</p>	 <p>Fix the work material firmly in a vise and/or other clamping fixture.</p>
 <p>Do not leave the work area with the hand tools still in operation. Confirm that the hand tools have completely stopped after switching them off.</p>	 <p>Perform an inspection before use. Clean the inside of the collet and tool shank, chips or fine metals inside the collet could cause tool slippage and result in damage to machinery or bodily injury.</p>

 <p>Fasten the chuck firmly. Make sure the tool is intact in the chuck to avoid tool slippage.</p>	 <p>Do not apply high pressure or pry to the tools. This can break and/or bend the tools. Use the tools within their design limitation. Excessive pressure will decrease the efficiency of your work and cause excessive wear of the tools.</p>										
 <p>Do not use damaged or broken electric cords and air hoses.</p>	 <p>Check the tools carefully before use. Confirm that the tools are free of chips, cracks, splits, scratches, lack of bonding, deformation, etc.</p>										
 <p>Start at low speed and gradually increase to insure safe work. This is particularly important for the use of new tools, large cutting tools and elastic tools such as rubber grindstone, sander and brush tools.</p>	 <p>Stop grinding or polishing immediately whenever unusual sounds, vibrations, or wear are found. Restart the work only after the problem is solved.</p>										
 <p>Store the tools and hand tools in a cool and dry place.</p>	 <p>Only use attachments, parts, consumable articles and accessories produced by NAKANISHI INC.</p>										
 <p>The tools should be used by taking care of the overhang and below maximum allowable speed. The catalogue shows the maximum allowable speed at 10 mm overhang (distance between the face of the collet and the top of the tool shank).</p>	<p>Decrease the speed as shown in the table below, if you are using a longer overhang than 10 mm.</p> <table border="1"> <thead> <tr> <th>Overhang</th> <th>Maximum allowable speed (min⁻¹)</th> </tr> </thead> <tbody> <tr> <td>Less than 10 mm</td> <td>Shown in the catalogue (A)</td> </tr> <tr> <td>Less than 20 mm</td> <td>(A) x 0.5</td> </tr> <tr> <td>Less than 25 mm</td> <td>(A) x 0.3</td> </tr> <tr> <td>Less than 50 mm</td> <td>(A) x 0.1</td> </tr> </tbody> </table>	Overhang	Maximum allowable speed (min ⁻¹)	Less than 10 mm	Shown in the catalogue (A)	Less than 20 mm	(A) x 0.5	Less than 25 mm	(A) x 0.3	Less than 50 mm	(A) x 0.1
Overhang	Maximum allowable speed (min ⁻¹)										
Less than 10 mm	Shown in the catalogue (A)										
Less than 20 mm	(A) x 0.5										
Less than 25 mm	(A) x 0.3										
Less than 50 mm	(A) x 0.1										

The pages are organized by code number, so you can find the code number you need by checking the code numbers printed at the top of the left and right pages.

SHANK DIAMETER

SHANK $\phi 3.0$

Indicates the shank diameter of various types of shafted tools.

※ NAKANISHI micro grinders use a collet system to maintain high precision. Please prepare a collet that corresponds to each shank diameter.

Grit Size (Mesh Size)

#180

This indicates the size (roughness) of the abrasive grains used in various types of polishing / grinding materials. The larger the number, the smaller (finer) the grit size, and conversely, the smaller the number, the larger (coarser) the grit size (roughness). This is the most significant factor that affects the roughness of the finished surface.

- Rough Finishing 46, 54, 60, 70, 80, 90
- Pre Finishing 100, 120, 150, 180
- Middle Finishing 220, 240, 280, 320, 400
- Finishing 500, 600, 700, 800, 1000
- Extra Fine to Mirror Finishes 1200, 1500, 1800, 2000, 3000, 4000, 6000, 8000...

Maximum Allowable Speed

30,000 min⁻¹

Do not exceed the maximum allowable speed. For safety reasons, always use below the indicated allowable speed.

If this is the first time you are using the equipment or tip tool, start with a low speed and gradually increase it to reach the most appropriate speed for use.

Conditions may vary depending on the type, shape, overall length, and wear condition of the tip tool, so please work with constant care.

※ The maximum allowable operating speed is for when the overhang is under 10 mm. If the overhang is more than 10 mm, please reduce the speed.

For details, please refer to "Precautions for use" on page A-3~4.

※ Make sure there are no mechanical defects in the equipment prior to each use.

Actual size illustration (excluding some tools and overall length)

Shank diameter of the tools listed on the facing page

The beginning of the Code Numbers listed on the facing page. (The last number listed is found on the right side.)

Quantity in Standard Package

1 pc./pack

A standard package is the minimum shipping unit. This number shows the number of pieces in the standard package (bag, box, etc.). Please order the number of packages needed for the desired quantity.

11131~

**Angle Type Grinder
(Electric / Pneumatic)**
Exclusive Tools for "MINI ANGLE Type"

NAKANISHI Angle Grinders are available with a wide range of tools for a variety of machining operations, from cutting to grinding, polishing and lapping.

SHANK DIAMETER

SHANK $\phi 1.6$

MINI Angle Type

Diamond Burs for Deep Hole Chamfering

SHANK $\phi 1.6$ 1 pc./pack

Diamond Burs for Deep Hole Chamfering

- Ideal for machining hardened steel, cemented carbide, ceramics, etc.

11131

11132

11133

11151

11152

11153

11154

11155

11156

Diamond Burs

Carbide Burs

Mounted Abrasive Points

Abrasive Rubber Points

P.5-31

Photograph of the basic shape

Maximum Allowable Speed
Grit Size

Quantity in Standard Package

Overall length

Code No. (Order Number)

Note : Specifications may change without notice. The color of the tools in the catalog may differ from the actual color due to printing and other factors.

SHANK DIAMETER

Original tools that assist the LUSTER's powerful polishing ability to realize a speedy finish.
We have a wide variety of tools for a wide range of processes from filing to mirror finish.

- ▶ SHANK $\phi 3.0$
- ▶ SHANK $\phi 3.2$

Handy Type (reciprocating)
Tools for LUSTER



Grindstone Holder

1 pc./pack Maximum clampable thickness 4.5 x width 11 mm

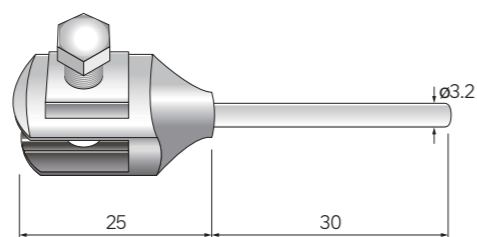
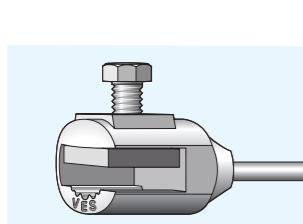

Code No.
62502

1 pc./pack Maximum clampable thickness 11 x width 13.5 mm

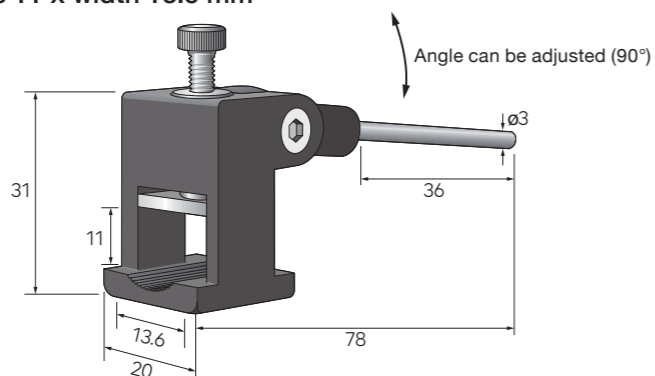

Code No.
62505

Ceramic Fiber Holder・Grindstone Holder

1 pc./pack Maximum clampable thickness 1 x width 4 mm

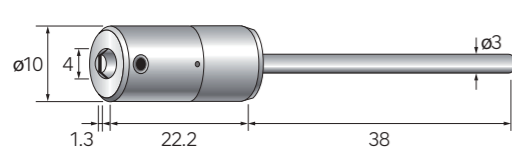

Code No.
62506

Maximum clampable thickness 1 x width 10 mm

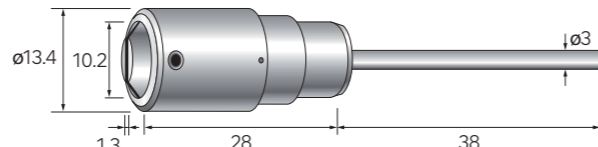

Code No.
62508

Maximum clampable thickness 1 x width 6 mm

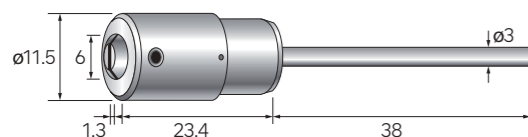

Code No.
62507

Grindstone Holder
Maximum clampable thickness 3 x width 6 mm

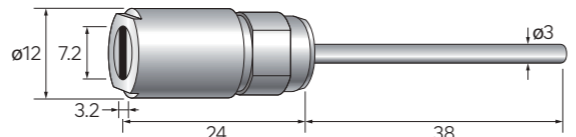

Code No.
62509

Flat Tip Holder

Attach the following Sandpaper and various polishing sheets.

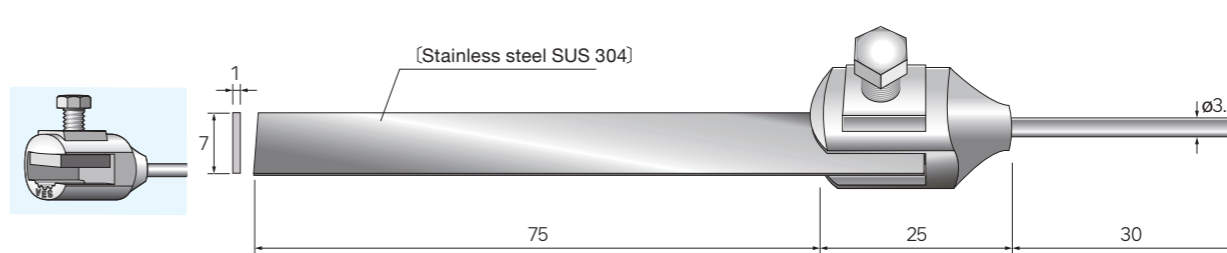

Code No.
62512

Square Pad Holder

The holder for polishing tips is ideal for polishing the bottom of a box shape.
The damper function allows the holder to continuously fit the work surface, and the angle can be freely adjusted to continuously capture the work surface for efficient polishing.

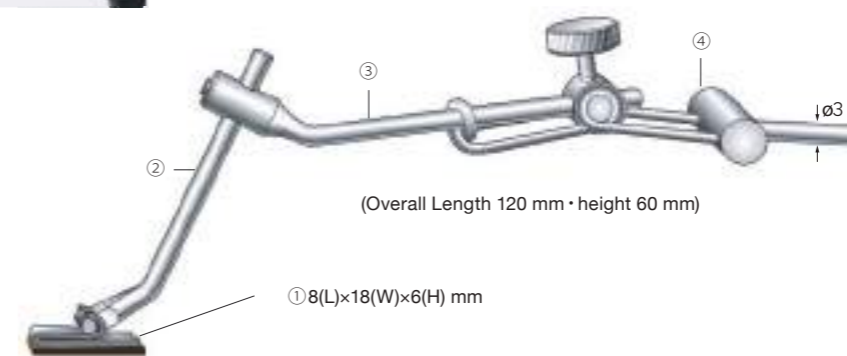

Code No.
62521

Parts	Code No.
① Rectangular Pad	62525
② Rod for Rectangular Pad	62526
③ Angle Rod	62527
④ Tool Holder with Spring	62751

※ Parts can be ordered separately.

Sandpaper

Please attach to a flat tip holder or rectangular pad holder.

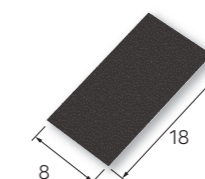

Grit Size	Code No.
# 120	62552
# 320	62555
# 600	62557
# 1000	62559

Adhesive Back

SHANK DIAMETER



Original tools that assist the LUSTER's powerful polishing ability to realize a speedy finish.
We have a wide variety of tools for a wide range of processes from filing to mirror finish.



- Suitable for finishing of high-hardness metals such as mold steel (removal of hardened electroplated layer, etc.) and heat treated metal. Also suitable for polishing of cemented carbide molds, aluminum molds, and copper alloy molds.
- Ideal for grinding and polishing fine parts and rib slits of various molds for plastics, press, forging, headers, die-casting, etc.
- It can be used for grinding and polishing ceramics, precision electronic parts, and precision mechanical parts.
- It can handle a wide range of processing, from grinding of complex shapes and minute parts to mirror-polished finishes.

Handy Type (reciprocating)
Tools for LUSTER

Electroplated Diamond File



- <Features>
- Diamond abrasive grains are electroplated to the file surface (electroplated coating).
 - The amount of protruding diamond grains is large, and the cutting performance is excellent.
 - We use carefully selected diamond abrasive grains and electroplate them particularly strongly for machine finishing, so they have excellent durability.
 - It is suitable for finishing of high-hardness metals such as mold steel, heat treated metal, cemented carbide, and ceramics, polishing and finishing of various molds, and deburring and correction of machine parts.

SHANK Ø3.0 1 pc./pack Electroplated Diamond File The illustrations on this page are 80% of the actual size.

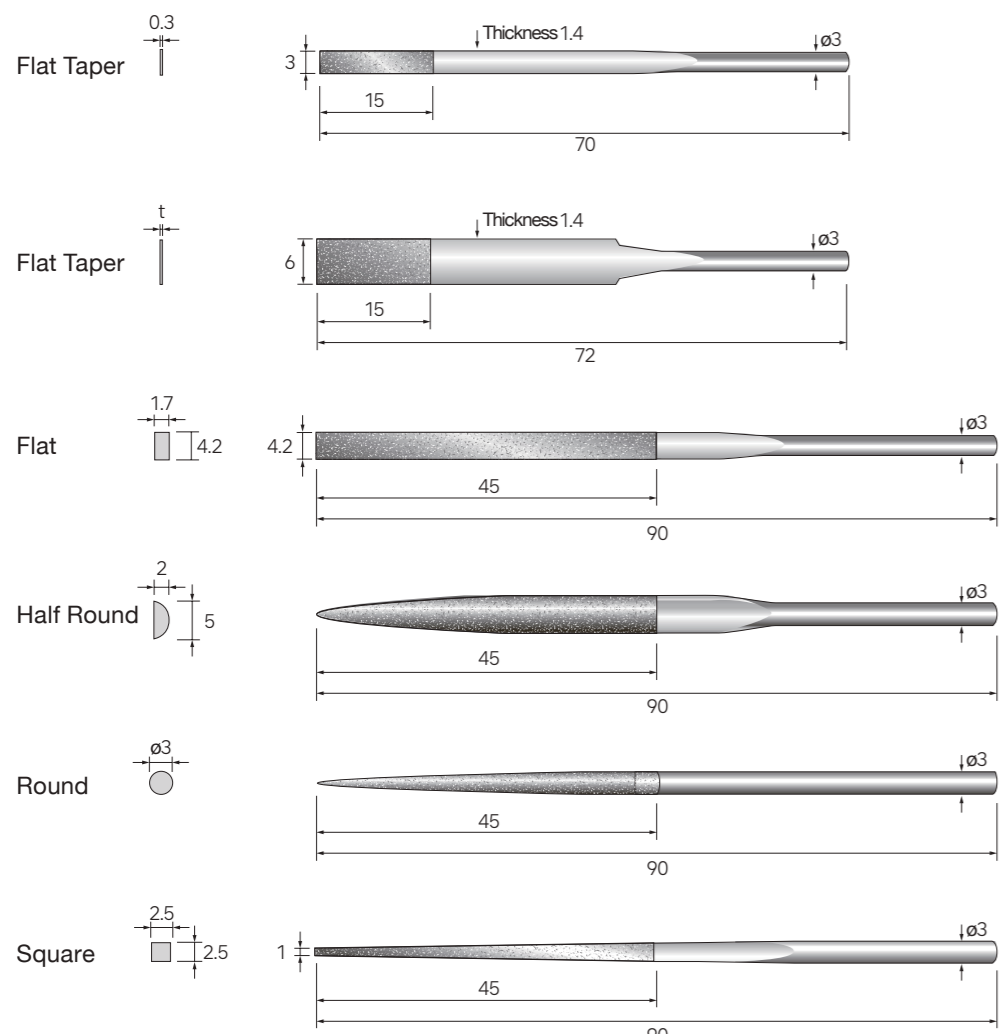

Grit Size	Code No.
#200	62301
#400	62302
#600	62303

Thickness (t)	Grit Size	Code No.
0.45	#200	62305
0.4	#400	62306
0.35	#600	62307

#150 62311

#150 62313

#150 62315

#150 62317

SHANK Ø3.0 1 pc./pack

Tool Holder with Spring



Common Tools for LUSTER and MINI-LUSTER

- <Features>
- This is a utility holder that allows files and various tools to fit the abrasive tip to the work surface by the spring damper function.
 - The damper function absorbs all the vertical movement (flapping and bouncing) of the abrasive tool during reciprocating motion, enabling ideal reciprocating motion.
 - This makes it possible to apply the grinding tool flatly to the work surface, resulting in highly efficient even and smooth surfaces.
 - Diamond files, various files, ceramic fiber grindstones (Ø3 mm), various lapping sticks, various holders, etc. can be installed and used.

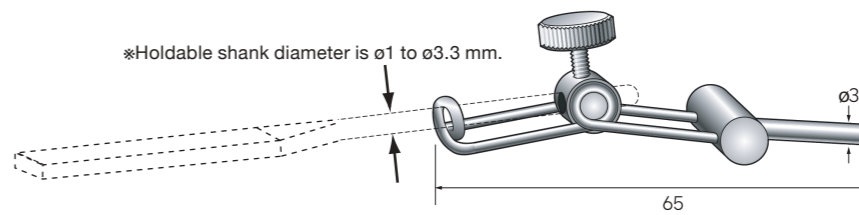

Code No.
62751

57301~

SHANK DIAMETER

SHANK $\phi 3.0$



Handy Type Reciprocating Grinder (Electric / Pneumatic) Exclusive Tools for "LUSTER"

Original tools that assist the LUSTER's powerful polishing ability to realize a speedy finish. We have a wide variety of tools for a wide range of processes from filing to mirror finish.



~57410

Handy Type (reciprocating)
Tools for LUSTER

Precision Finishing File (Flat, Round, Square, Triangular, Half-Round)

<Features>

- Ideal for precision finishing of general steel, brass, copper alloy, hard resin, etc.
- Carefully selected materials and advanced grading technology provide superior sharpness and durability.
- Speedy finishing is possible by using the LUSTER series (Electric / Pneumatic).



Coarse File for Plastic and Woodworking (Flat, Round, Square, Triangular, Half-Round)

<Features>

- Ideal for filing wood products, plywood, compressed materials, and plastics.
- It is characterized by its superior sharpness and durability due to its advanced grading technology.
- It can be used with the Luster Series (Electric / Pneumatic) for speedy finishing.



SHANK $\phi 3.0$ 3 pcs./pack

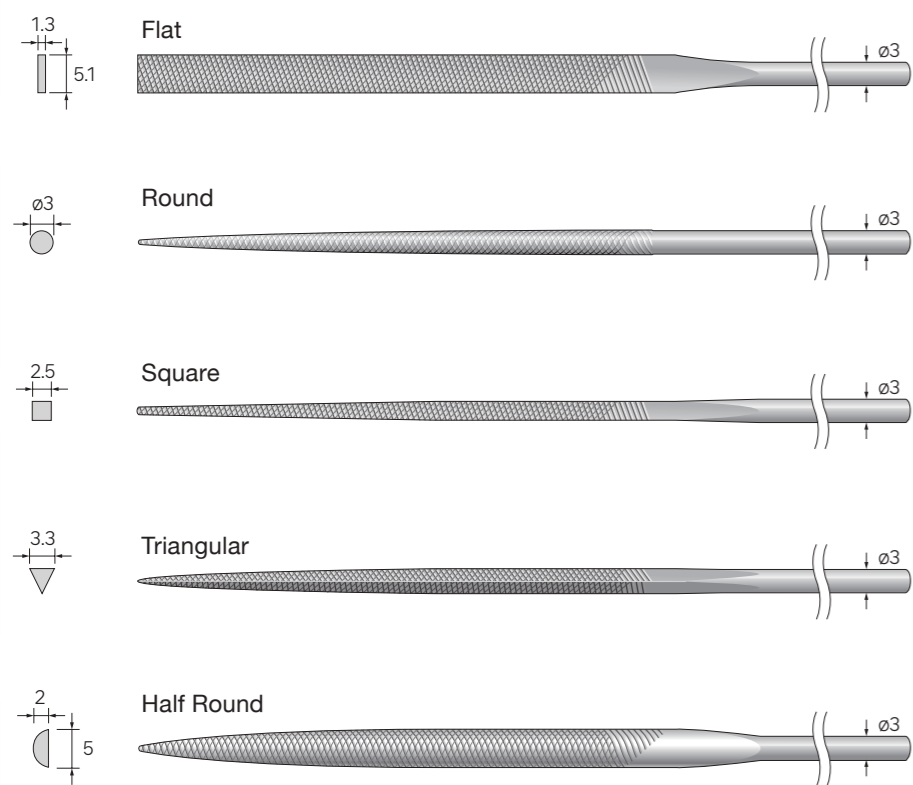

Overall length / 140 mm, Filing area / 70 mm

Medium-Grit		Fine-Grit	
Code No.		Code No.	
57301	Flat	57311	Flat
57302	Round	57312	Round
57303	Square	57313	Square
57304	Triangular	57314	Triangular
57305	Half Round	57315	Half Round

Set of 5 types

Precision Finishing File Medium-Grit Set
(No.57301~No.57305 Contains 1 pc. each)

No.57309

Precision Finishing File Fine-Grit Set
(No.57311~No.57315 Contains 1 pc. each)

No.57319

SHANK $\phi 3.0$ 3 pcs./pack

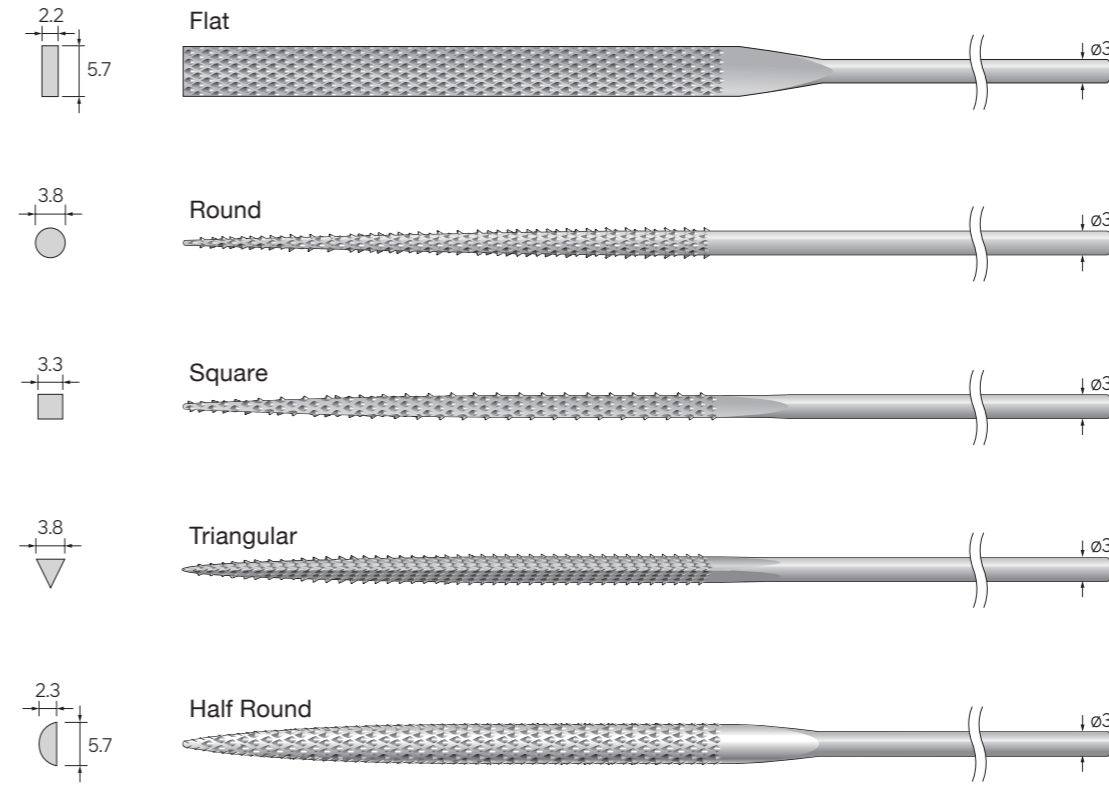

Overall length / 140 mm
Filing area / 69 mm

Code No.	
57401	Flat
57402	Round
57403	Square
57404	Triangular
57405	Half Round

Set of 5 types

Coarse File Plastic and Woodworking Set
(No.57401~No.57405 Contains 1 pc. each)

No.57410

62506~

SHANK DIAMETER

- SHANK $\phi 3.0$
- SHANK $\phi 3.2$



Pencil Type Reciprocating Grinder (Electric / Pneumatic) Exclusive Tools for Polisher "MINI-LUSTER"

Designed to be easy to use, taking advantage of the features of the lightweight pencil type. The line-up of NAKANISHI's original tools is ideal for delicate and precise abrasive finishing.

(~62982)

Pencil Type (reciprocating) Tools for MINI-LUSTER



1 pc./pack

Ceramic Fiber Holder·Grindstone Holder

Maximum clampable thickness 1 x width 4 mm

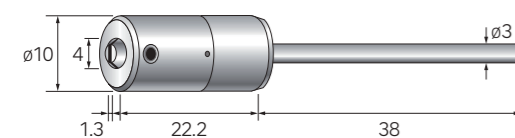

Code No.
62506

Maximum clampable thickness 1 x width 10 mm

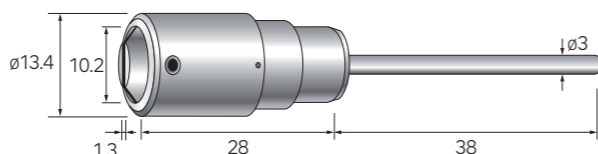

Code No.
62508

Maximum clampable thickness 1 x width 6 mm

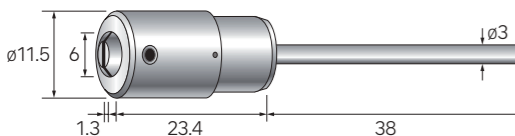

Code No.
62507

Grindstone Holder
Maximum clampable thickness 3 x width 6 mm

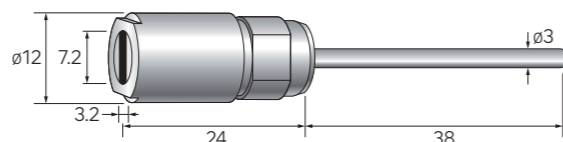

Code No.
62509

Maximum clampable thickness 1 x width 6 mm

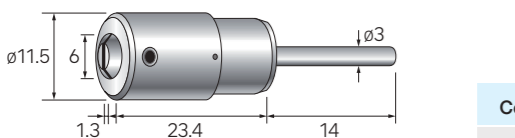

Code No.
62510

2 pcs./pack

Ceramic Fiber Grindstone

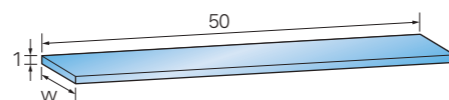
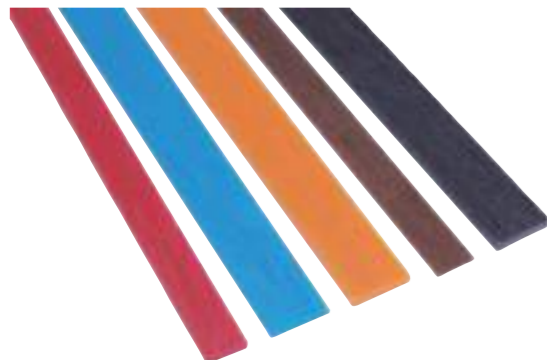

Grit Size	Color	W=4 mm	W=6 mm	W=10 mm
		Code No.	Code No.	Code No.
# 120	Violet	60511	60516	60521
# 220	Brown	60512	60517	60522
# 400	Orange	60513	60518	60523
# 800	Blue	60514	60519	60524
# 1200	Red	60515	60520	60525

1 pc./pack

Flat Tip Holder

- A variety of polishing tips can be attached to MINI-LUSTER for efficient finish polishing.
- In addition to the polishing tips listed below, a wide range of cut polishing sheets (diamond film, felt sheets, etc.) can be used.
- The compact holder can be mounted on the pencil type MINI-LUSTER in a well balanced manner and is easy to use.

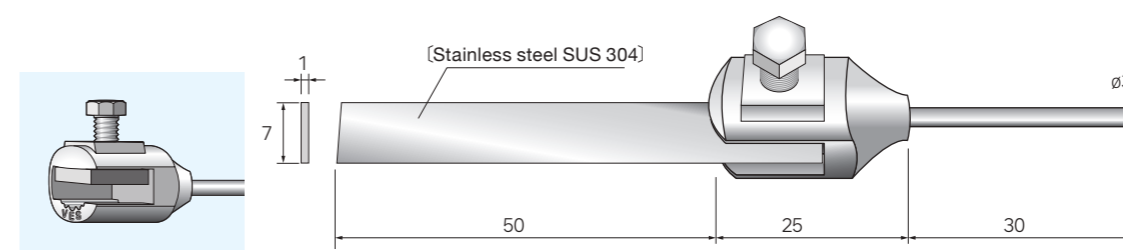

Code No.
62982

100 pcs./pack

Sandpaper

Please attach to a flat tip holder or rectangular pad holder.

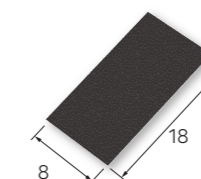

Adhesive Back

Grit Size	Code No.
# 120	62552
# 320	62555
# 600	62557
# 1000	62559

1 pc./pack

Tool Holder with Spring



<Features>

- This is a utility holder that allows files and various tools to fit the abrasive tool to the work surface by the spring damper function.
- The damper function absorbs all the vertical movement (flapping and bouncing) of the abrasive tool during reciprocating motion, enabling ideal reciprocating motion.
- This makes it possible to apply the grinding tool flatly to the work surface, resulting in highly efficient, even and smooth surfaces.
- Diamond files, various files, ceramic fiber grindstone ($\phi 3$ mm), various lapping sticks, various holders, etc. can be installed and used.

*Holdable shank diameter is $\phi 1$ to $\phi 3.3$ mm.

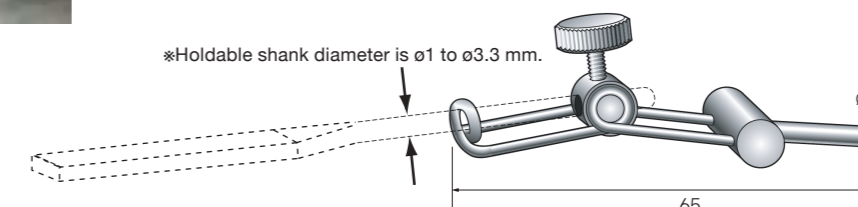

Code No.
62751

62801 ~

SHANK DIAMETER

SHANK $\phi 3.0$



Pencil Type Reciprocating Grinder (Electric / Pneumatic) Exclusive Tools for Polisher "MINI-LUSTER"

Designed to be easy to use, taking advantage of the features of the lightweight pencil type. The line-up of NAKANISHI's original tools is ideal for delicate and precise abrasive finishing.



~62883

Pencil Type (reciprocating) Tools for MINI-LUSTER

Electroplated Diamond File



<Features>

- Diamond abrasive grains are electroplated to the file surface (electroplated coating).
- The amount of protruding diamond abrasive grains is large, and the cutting performance is excellent.
- We use carefully selected diamond abrasive grains and electroplate them particularly strongly for machine finishing, so they have excellent durability.
- It is suitable for finishing of high-hardness metals such as mold steel, heat treated metal, cemented carbide, and ceramics, polishing and finishing of various molds, and deburring and correction of machine parts.

SHANK $\phi 3.0$ 1 pc./pack Electroplated Diamond File

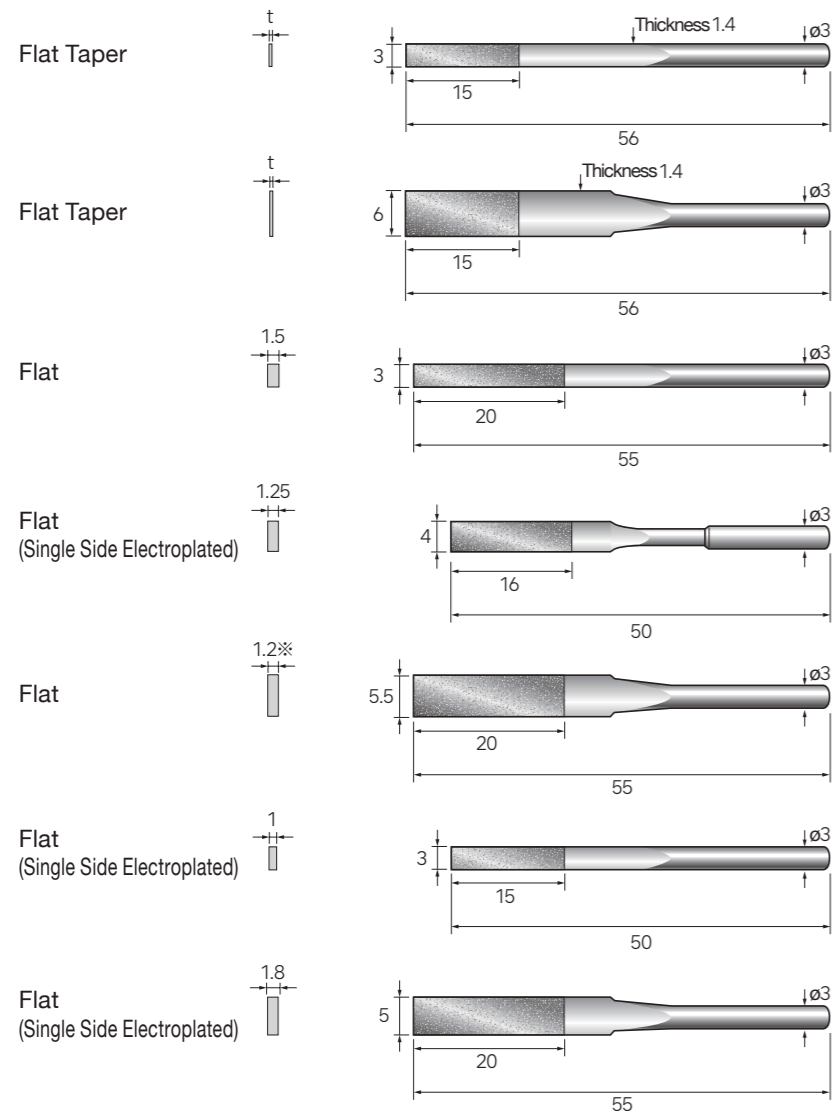

Thickness (t)	Grit Size	Code No.
0.5	#200	62801
0.4	#400	62802
0.35	#600	62803

0.5	#200	62805
0.4	#400	62806
0.35	#600	62807

#150	62811
#200	62812
#400	62813

#100	62814
------	-------

#150	62815
#200	62816
#400	62817

* Thickness of 62815 is 1.4 mm.

#150	62821
#200	62822
#400	62823

#150	62825
#200	62826
#400	62827

SHANK $\phi 3.0$ 1 pc./pack Electroplated Diamond File

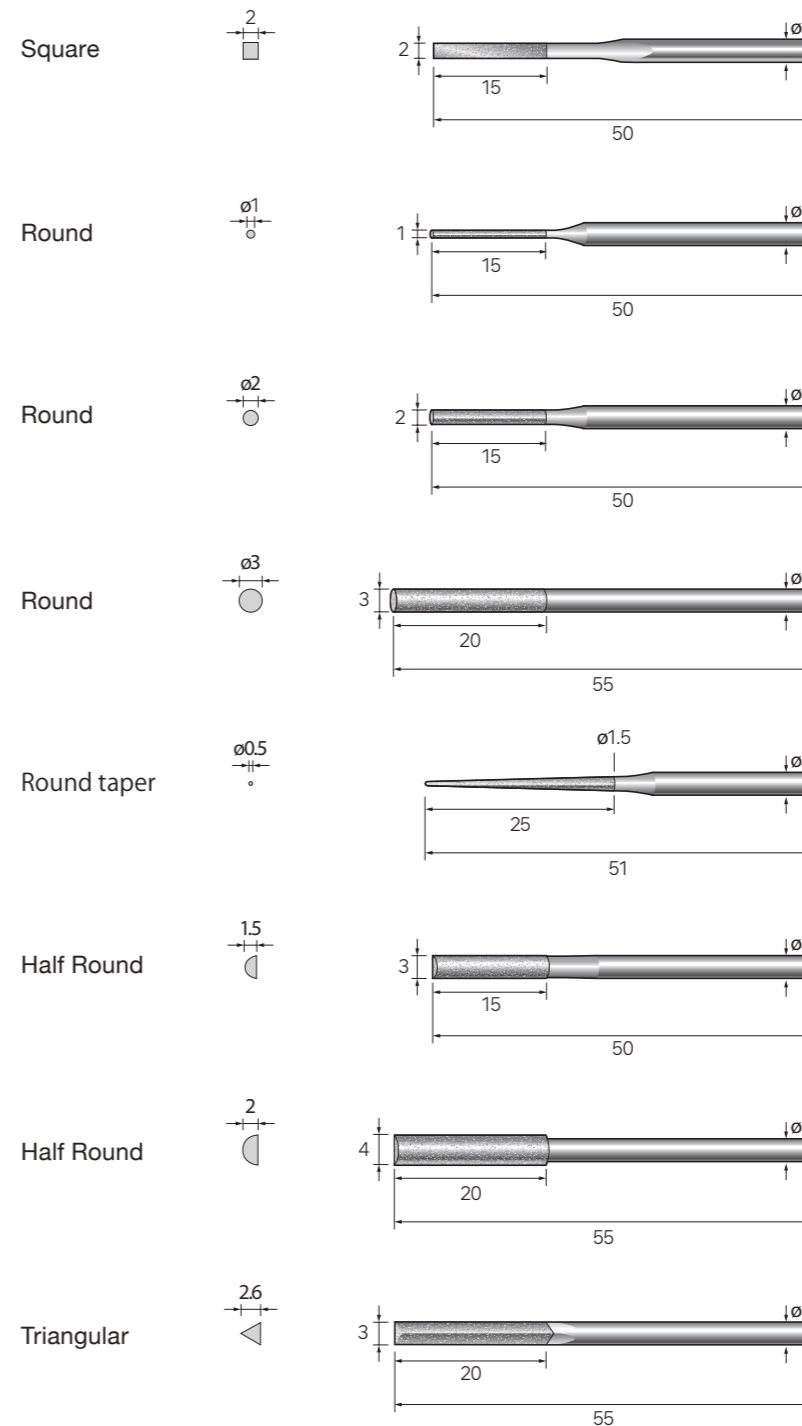

Grit Size	Code No.
#150	62831
#200	62832
#400	62833

#100	62840
#150	62841
#200	62842
#400	62843

#150	62845
#200	62846
#400	62847

#150	62851
#200	62852
#400	62853

#150	62855
#200	62856
#400	62857

#150	62865
#200	62866
#400	62867

#150	62871
#200	62872
#400	62873

#150	62881
#200	62882
#400	62883

▲ For safety reasons, always wear protective equipment such as safety glasses. Use at or below the indicated maximum allowable speed.

(51123~)

SHANK DIAMETER

SHANK ϕ 3.0



Pencil Type Swing Polisher (Electric / Pneumatic) Exclusive Tools for "SWING-LUSTER"

The left-right horizontal swinging file swings around narrow areas (ribs), corners, grooves (runners), etc., which cannot be polished with a reciprocating file, to achieve speedy polishing.

(~62827)

Pencil Type (swing) Tools for "SWING-LUSTER"



Electroplated Diamond File



<Features>

- Diamond abrasive grains are electroplated to the file surface (electroplated coating).
- The amount of protruding diamond abrasive grains is large, and the cutting performance is excellent.
- We use carefully selected diamond abrasive grains and electroplate them particularly strongly for machine finishing, so they have excellent durability.
- It is suitable for finishing of high-hardness metals such as mold steel, heat treated metal, cemented carbide, and ceramics, polishing and finishing of various molds, and deburring and correction of machine parts.

SHANK ϕ 3.0 1 pc./pack Electroplated Diamond File

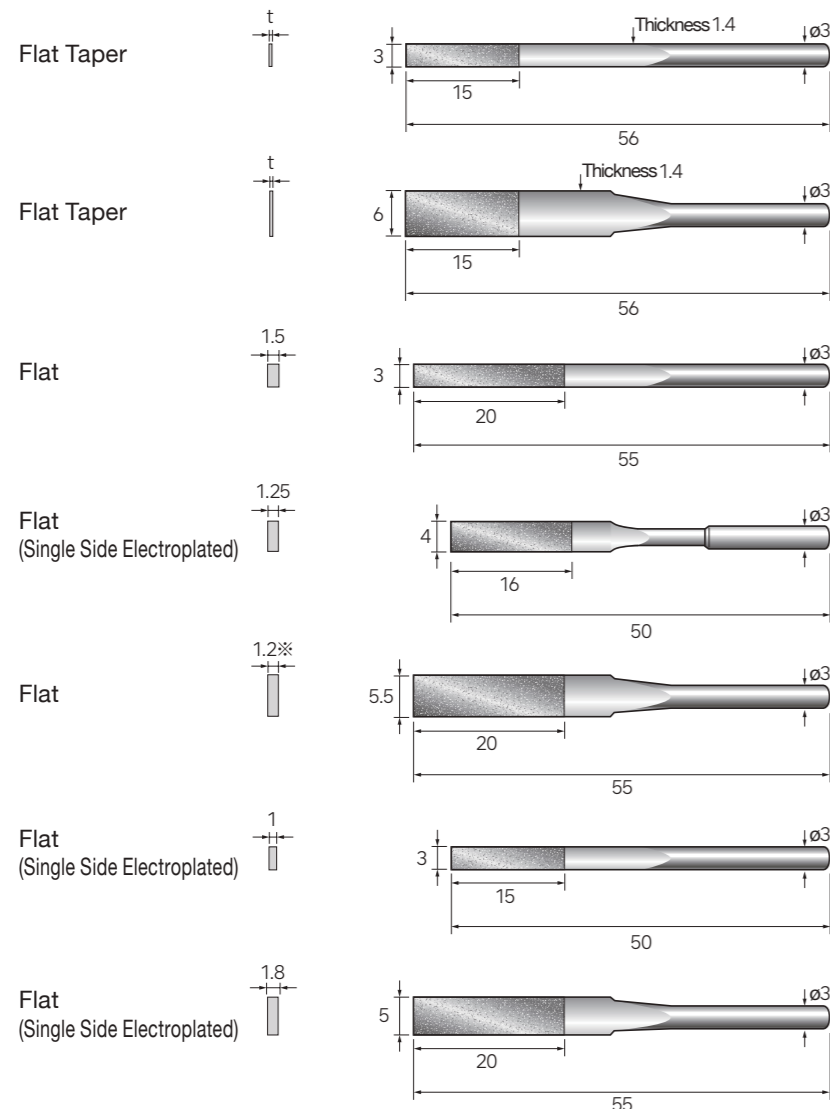

Thickness (t)	Grit Size	Code No.
0.5	#200	62801
0.4	#400	62802
0.35	#600	62803

0.5	#200	62805
0.4	#400	62806
0.35	#600	62807

#150	62811
#200	62812
#400	62813

#100	62814
------	-------

#150	62815
#200	62816
#400	62817

※ Thickness of 62815 is 1.4 mm.

#150	62821
#200	62822
#400	62823

#150	62825
#200	62826
#400	62827

2 pcs./pack

Flat type 50 mm

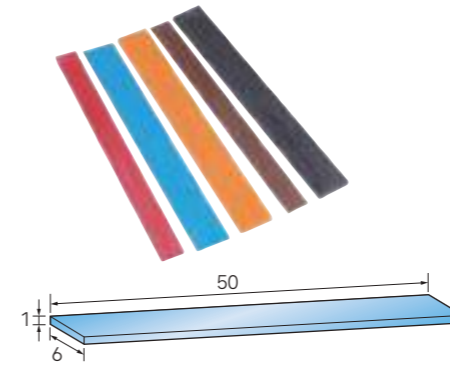

Ceramic Fiber Grindstone Tip

Thickness 1 mm x width 6 mm

Grit Size	Color	Code No.
# 120	Violet	60516
# 220	Brown	60517
# 400	Orange	60518
# 800	Blue	60519
# 1200	Red	60520

Round bar type 50 mm

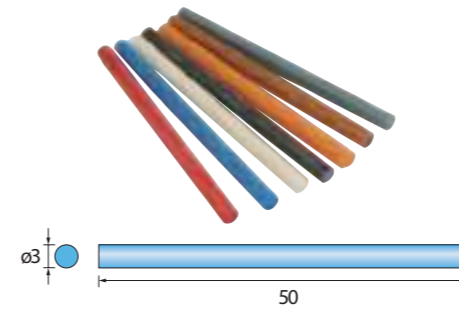

ϕ 3 mm

Grit Size	Color	Code No.
# 220	Gray	60551
# 300	Mazenta	60552
# 400	Orange	60553
# 600	Black	60554
# 800	Blue	60555
# 1000	White	60556
# 1200	Red	60557



With 6 mm wide flat tip



With ϕ 3 mm round bar



With sharpened tip of round bar

SHANK ϕ 3.0 1 pc./pack

Ceramic Fiber Holder

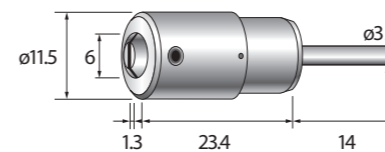

Max. clampable thickness 1 mm x width 6 mm

Code No.

62510

SHANK ϕ 3.0 1 pc./pack

Ceramic Fiber Brush

The grindstone is now in brush form.



Brush diameter	Brush length	Overall length	Finishing (Pink)	Middle Finishing (Red)	Rough Finishing (Blue)
ϕ 2	15	52*	51123	51133	51141
ϕ 2.5	15	52*	51124	51134	51142

※Blue's overall length is 50 mm.

▲ For safety reasons, always wear protective equipment such as safety glasses. Use at or below the indicated maximum allowable speed.

SHANK DIAMETER

NAKANISHI Angle Grinders are available with a wide range of tools for a variety of machining operations, from cutting to grinding, polishing and lapping.



Angle Type

SHANK Ø3.0 5 pcs./pack

Special Rubber Pads for Abrasive and Felt Discs

- It is used by attaching various types of polishing discs.
- The elasticity of the rubber makes it ideal for finishing flat and curved surfaces.

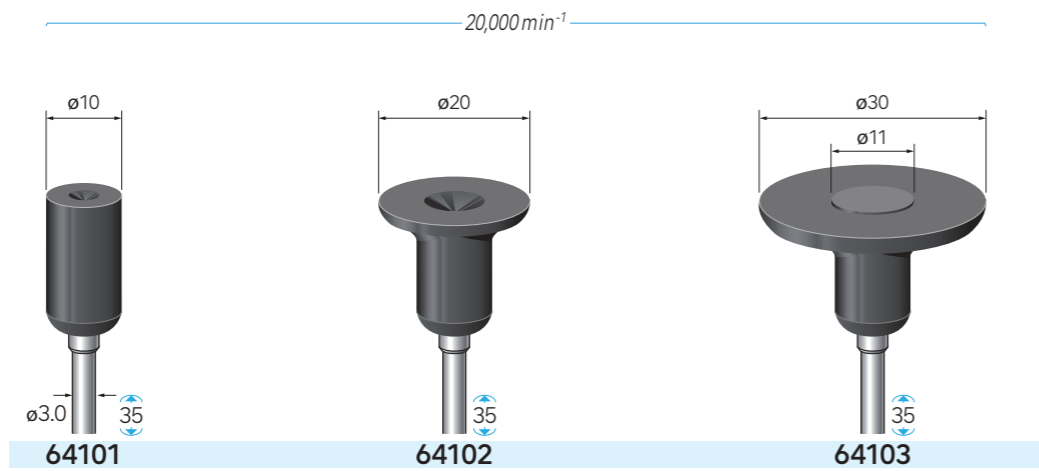

100 pcs./pack

Sandpaper Discs (paper base type)

- Suitable for metal, woodwork, painted surfaces and putty polishing
- Use in dry conditions



		Adhesive Back		
Grit Size		Ø11	Ø21	Ø31
# 80	64201	64211	64221	
# 120	64202	64212	64222	
# 180	64203	64213	64223	
# 240	64204	64214	64224	
# 320	64205	64215	64225	
# 400	64206	64216	64226	
# 600	64207	64217	64227	

100 pcs./pack

Sandpaper Discs (fabric base type)

- Ideal for metalworking
- Excellent durability
- Use in dry conditions

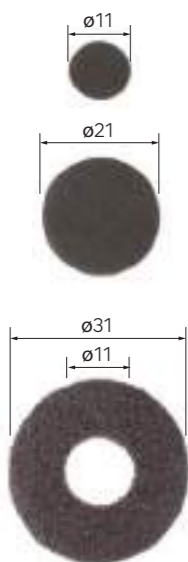

		Adhesive Back		
Grit Size		Ø11	Ø21	Ø31
# 60	64111	64121	64141	
# 80	64112	64122	64142	
# 120	64113	64123	64143	
# 180	64114	64124	64144	
# 240	64115	64125	64145	
# 320	64116	64126	64146	
# 400	64117	64127	64147	
# 600	64118	64128	64148	

100 pcs./pack

Zirconia Disks

- These discs are specially coated with zirconia abrasive grains to provide excellent cutting performance and durability for difficult-to-machine materials.
- Ideal for machining metals such as aluminium, stainless steel, copper alloys and brass, which are prone to clogging.



		Adhesive Back		
Grit Size		Ø11	Ø21	Ø31
# 60	64251	64261	64271	
# 80	64252	64262	64272	
# 120	64253	64263	64273	
# 150	64254	64264	64274	

NAKANISHI Angle Grinders are available with a wide range of tools for a variety of machining operations, from cutting to grinding, polishing and lapping.



20 pcs./pack

Felt Discs

- Ideal for use in combination with various abrasives (diamond compound, polishing compound) for finish polishing.
- Made from 100% high quality sheep's wool, with moderate elasticity and sufficient durability for repeated polishing operations.
- High wool density ensures that abrasives and abrasive grains are held in place and the surface is polished.

Adhesive Back

Product name	ø11	ø21	ø31
Felt Discs (1 mm thick) Soft	64331	64332	64333
Felt Discs (2 mm thick) Soft	64335	64336	64337

* Sheeted types are available.

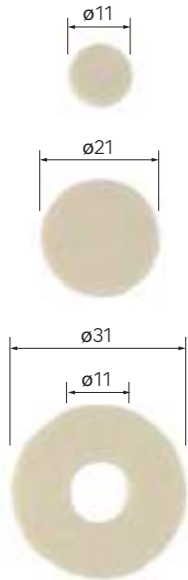

SHANK Ø3.0 5 pcs./pack

Rubber grinding wheel disc with shaft (Integrated rubber pad)

- The newly developed special rubber holds the abrasive grains with the right amount of hardness and boasts exceptional polishing ability.
- The grinding wheel part is integrally moulded into the rubber pad for superior workability.
- Highly efficient finishing of flat and curved surfaces with a soft touch.

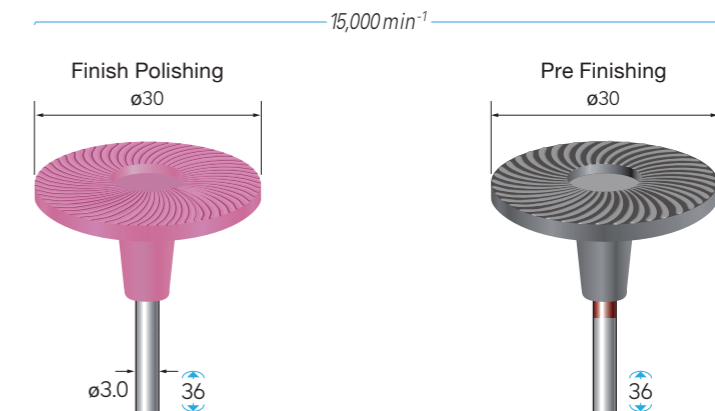

Finish Polishing

Grit Size	Color	WA abrasive grains	GC abrasive grains
# 80	Pink	64411	—
# 80	Purple	—	64421
# 120	Blue	64412	64422
# 180	Yellow	64413	—
# 180	Green	—	64423
# 220	Green	64414	64424
# 320	Purple	64415	64425
# 500	Orange	64416	—
# 500	Brown	—	64426

Pre Finishing (Excellent grindability)

Grit Size	Color	WA abrasive grains
# 80	Black(Red line)	64431
# 120	Black(Blue line)	64432

NAKANISHI Angle Grinders are available with a wide range of tools for a variety of machining operations, from cutting to grinding, polishing and lapping.



Angle Type

1 pc./pack

Diamond Discs (Full electroplated surface)

The base material is an ultra-thin copper alloy, with diamond abrasive grains electroplated over the entire surface.

- The metal base material has good electrodeposition plating conditions and adheres diamond abrasive grains uniformly and most firmly.
- Very good sharpness and durability.

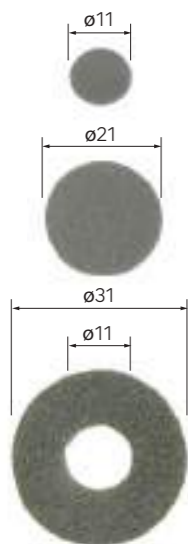

Adhesive Back

Grit Size	ø11	ø21	ø31
# 100	64451	64461	64471
# 140	64452	64462	64472
# 200	64453	64463	64473
# 280	64454	64464	64474
# 400	64455	64465	64475
# 600	64456	64466	64476
# 800	64457	64467	64477
# 1000	64458	64468	64478

* Sheeted types are available.

3 pcs./pack

Resin Bond Diamond Discs

Diamond abrasive grains are mixed with resin bond and coated on the resin base material.

- The resin component provides a uniform and stable finished surface and a soft grinding feel.
- ※ This resin bond type requires dressing only for the first use.
The cutting edges of the abrasive grains are exposed by lightly shaving the surface with a grindstone or diamond file.



Adhesive Back

Grit Size	ø11	ø21	ø31
# 80	64531	64541	64551
# 120	64532	64542	64552
# 180	64533	64543	64553
# 240	64534	64544	64554
# 400	64535	64545	64555
# 800	64537	64547	64557
# 1000	64538	64548	64558
# 2000	64539	64549	64559

1 pc./pack

Diamond Discs (Dot electroplated type for wet applications)

Nickel alloy pellets with diamond electrodeposition are strongly bonded to the Resin base material.

- The dot pattern is characterized by its strong grinding performance.
- Dot spaces allow chips and grinding fluid to flow smoothly.
- The resin base material is made of a fiber-filled resin that excels in flexibility and toughness.

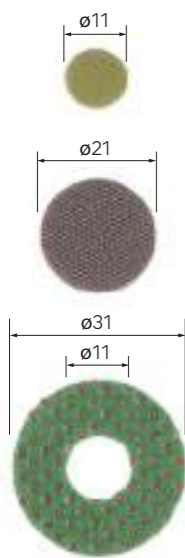

Adhesive Back

Grit Size	Color	ø11	ø21	ø31
# 60	Green	64501	64511	64521
# 120	Black	64502	64512	64522
# 200	Red	64503	64513	64523
# 400	Yellow	64504	64514	64524
# 800	Gray	64505	64515	64525

* Sheeted types are available.

11131~

SHANK DIAMETER

SHANK $\phi 1.6$

MINI Angle Type



Angle Type Grinder (Electric / Pneumatic) Exclusive Tools for "MINI ANGLE Type"

NAKANISHI Angle Grinders are available with a wide range of tools for a variety of machining operations, from cutting to grinding, polishing and lapping.



Compact Handy Belt Sander (Electric / Pneumatic) Exclusive Tools for "FINE BELT SANDER"

Powerful belt grinding power.
High-quality special belt for processing as desired.
The precise, lightweight, and compact NAKANISHI Belt Sander functions at 100%.

~65027

Fine Belt Sander

Diamond Burs for Deep Hole Chamfering

SHANK $\phi 1.6$ 1 pc./pack Diamond Burs for Deep Hole Chamfering

- Ideal for machining hardened steel, cemented carbide, ceramics, etc.

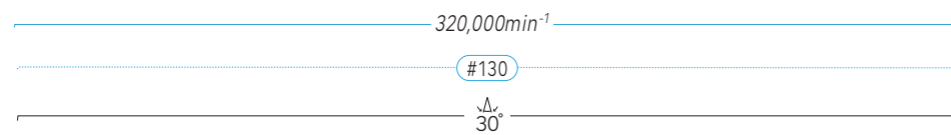
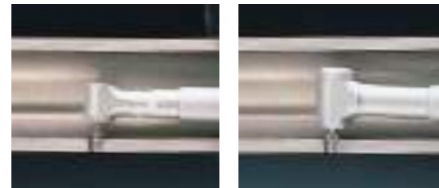

Diamond abrasive grains

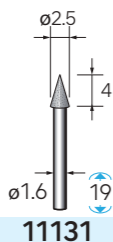

11131

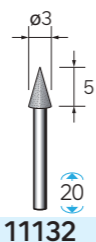

11132

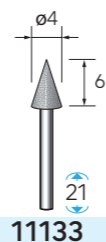

11133

SHANK $\phi 1.6$ 1 pc./pack Diamond Burs for Deep Hole Chamfering

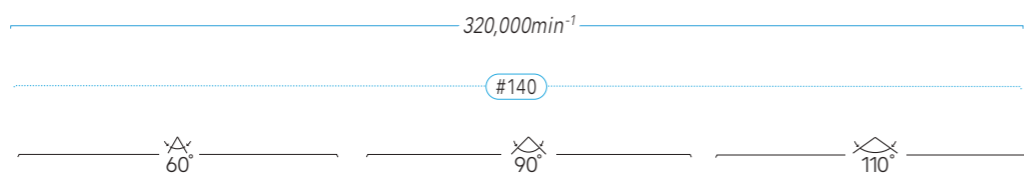

Diamond abrasive grains

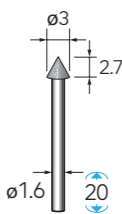

11151

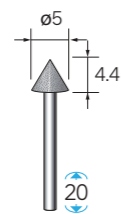

11152

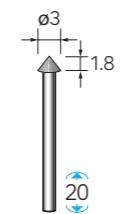

11153

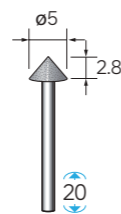

11154

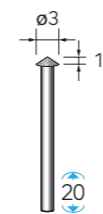

11155

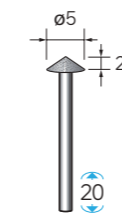

11156

Tools of $\phi 1.6$ mm shank



Diamond Burs



Carbide Burs



Mounted Abrasive Points



Abrasive Rubber Points

Sand Belt

30 pcs./pack Circumference 300 mm



- High quality Sanding Belt with excellent grindability and durability.
- Highly efficient grinding with a soft touch and less grain dropout even at high rim speeds.

● Assorted set for Pre Finishing (● mark)
4 Grit sizes (10 pcs. each)
Total 40 pcs. per pack

No.64931

● Assorted set for Finishing (● mark)
4 Grit sizes (10 pcs. each)
Total 40 pcs. per pack

No.64932

For metal processing			
	W=4 mm	W=6 mm	W=8 mm
Grit Size	Code No.	Code No.	Code No.
# 80	64901	64911	64921
# 120	64902	64912	64922
# 180	64903	64913	64923
# 240	64904	64914	64924
# 320	64905	64915	64925
# 400	64906	64916	64926
# 600	—	—	64927
# 800	—	—	64928

Zirconia Belt

30 pcs./pack Circumference 300 mm



- Ideal for machining metals such as aluminium, stainless steel, copper alloys and brass, which are prone to clogging.
- These belts are specially coated with zirconia abrasive grains to provide excellent durability for difficult-to-grind materials.

● Assorted set 8 mm width
All 3 Grit sizes (10 pcs. each)
Total 30 pcs.

No.64975

Grit Size	Code No.
# 80	64971
# 100	64972
# 120	64973

Diamond Belt

3 pcs./pack Hard type (circumference 300 mm)



- Excellent cutting performance enables high productivity and cost reduction.
- Excellent wear resistance and durability, and stable finish machined surfaces can be maintained.
- Suitable for highly efficient machining of carbide, hardened steel, mold steel, special steel, ceramics, FRP, carbon fiber, glass, stone, and difficult-to-machine materials.

● Assorted set 8 mm width
All 5 Grit sizes (1 pc. each)
Total 5 pcs.

No.65019

Hard type			
Grit Size	Code No.	Grit Size	Code No.
# 80	65011	# 320	65015
# 120	65012	# 600	65017
# 240	65014		

3 pcs./pack Soft type (circumference 300 mm)



● Assorted set 8 mm width
All 8 Grit sizes (1 pc. each)
Total 8 pcs.

No.65030

Soft type			
Grit Size	Code No.	Grit Size	Code No.
# 120	65021	# 400	65028
# 180	65022	# 600	65025
# 240	65023	# 800	65026
# 320	65024	# 1000	65027